

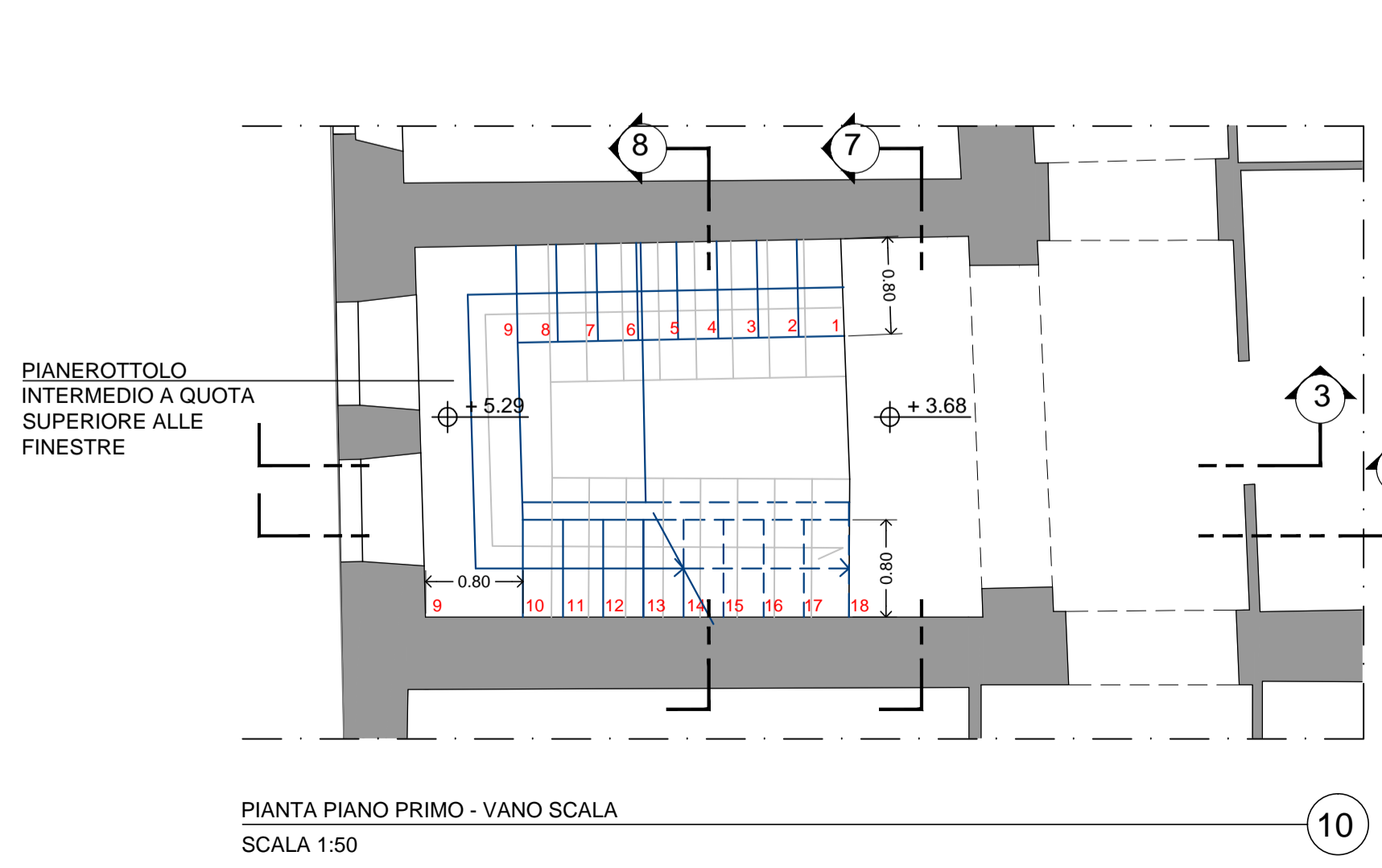

SCALA C.D.D. 11
 CODICE 11
 DATA _____

SCHEDA: PROGETTO NUOVA SCALA
 PROGETTO: VILLA E CANTINA DELL'AZIENDA AGRICOLA MONTEMELINO - Ristrutturazione
 Edilizia ed Ampliamento in Variante al PRG vigente e adottato - Procedimento SUAP
 ARCH. ANDREA PALOMBARO
 CORSO VITTORIO EMANUELE II, 282/284 - 00186 ROMA - ITALY
 TEL. STUDIO: 066882844 - FAX STUDIO: 066882664 - CELL.: 3471013386 - EMAIL: palombaro.studio@gmail.com
 REVISIONI: 1. _____ 2. _____ 3. _____ 4. _____

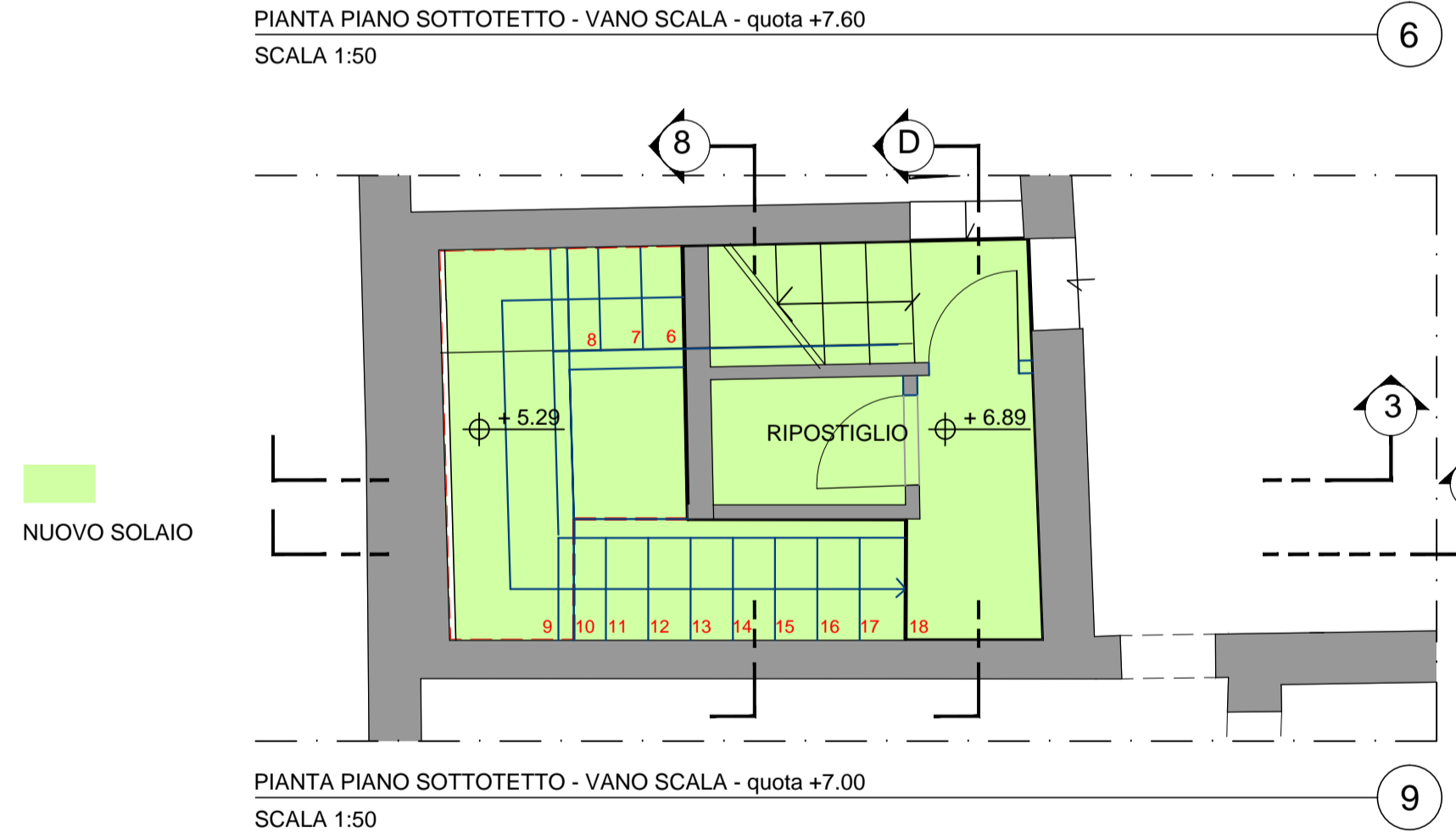
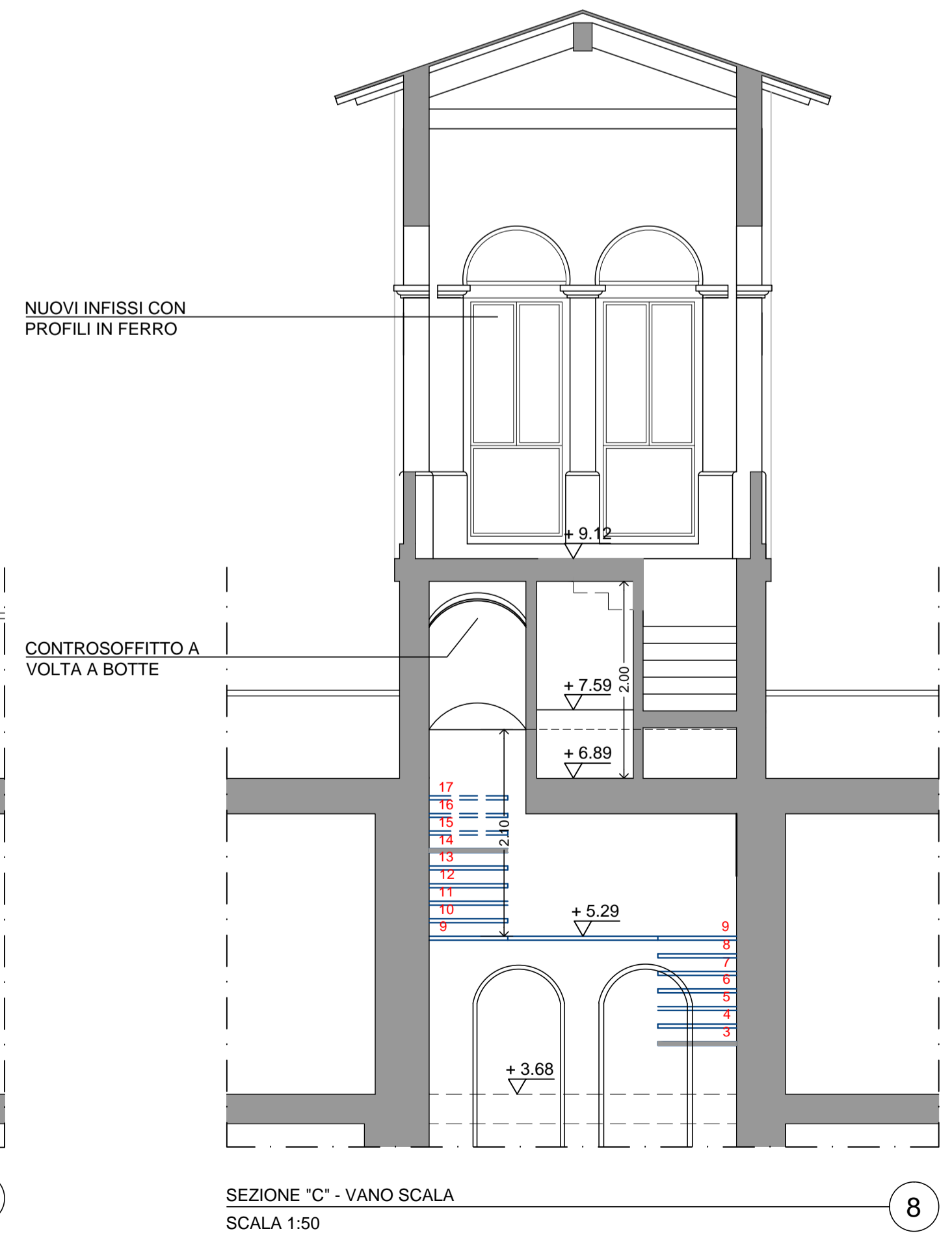
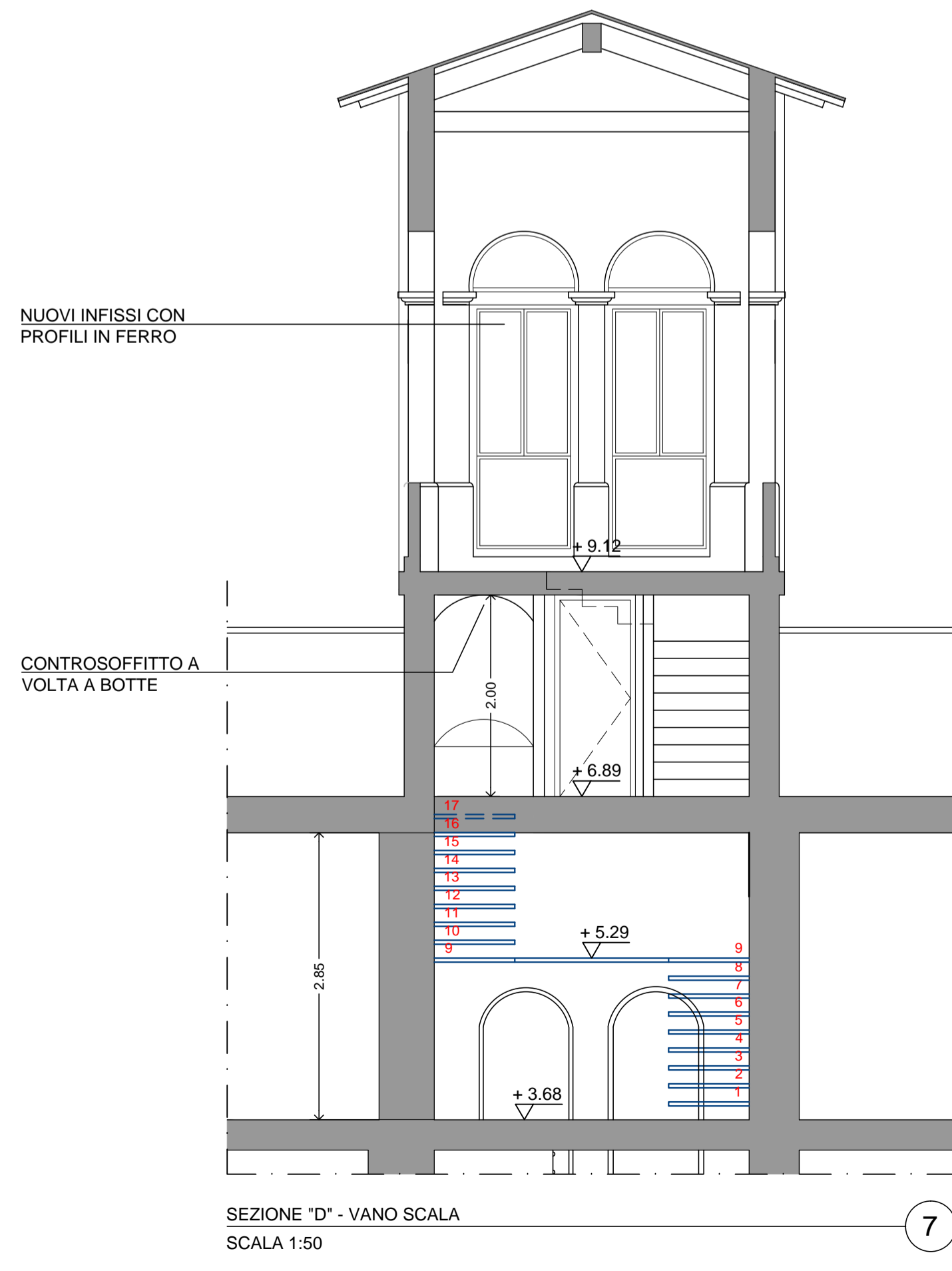
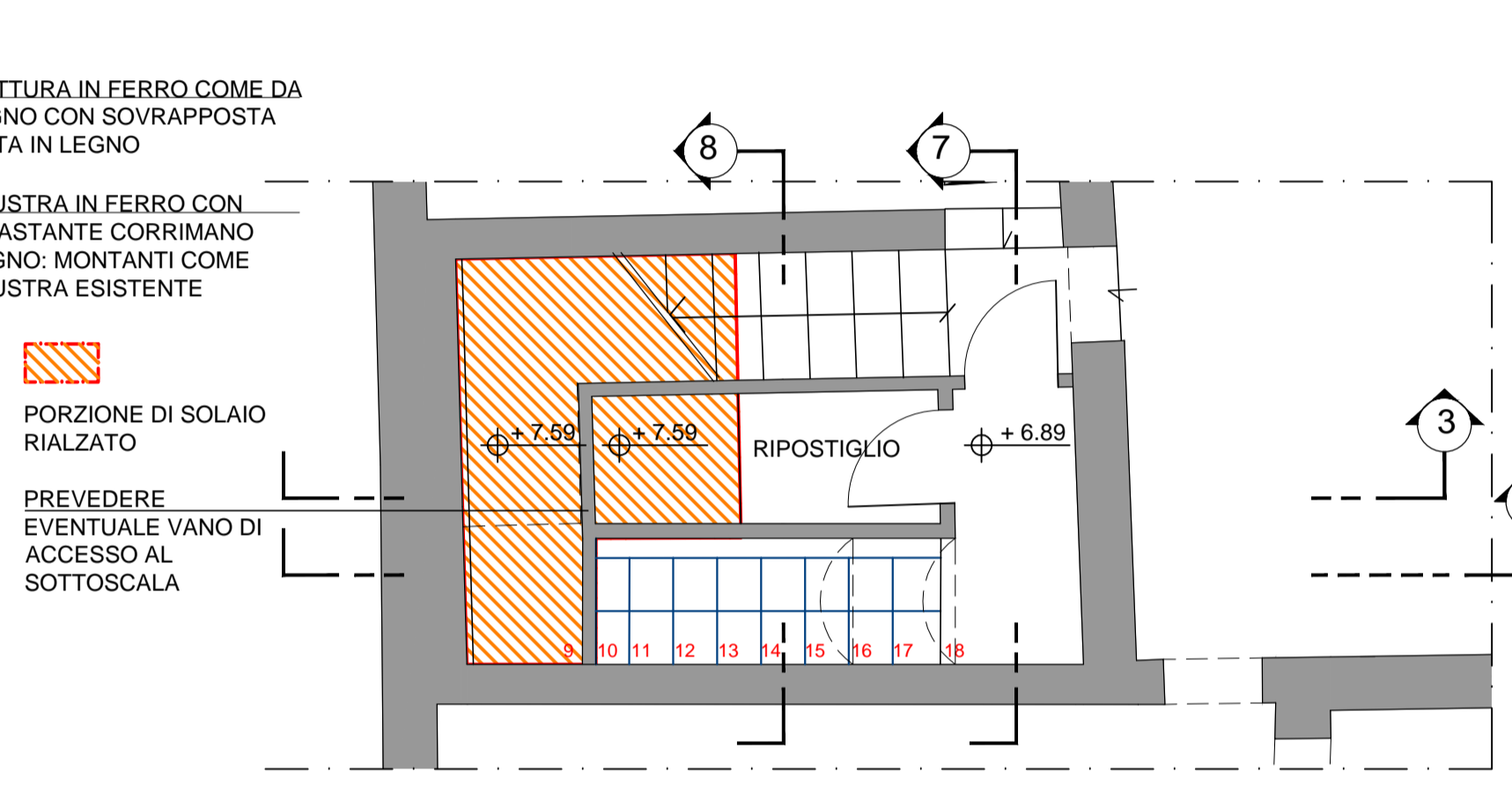
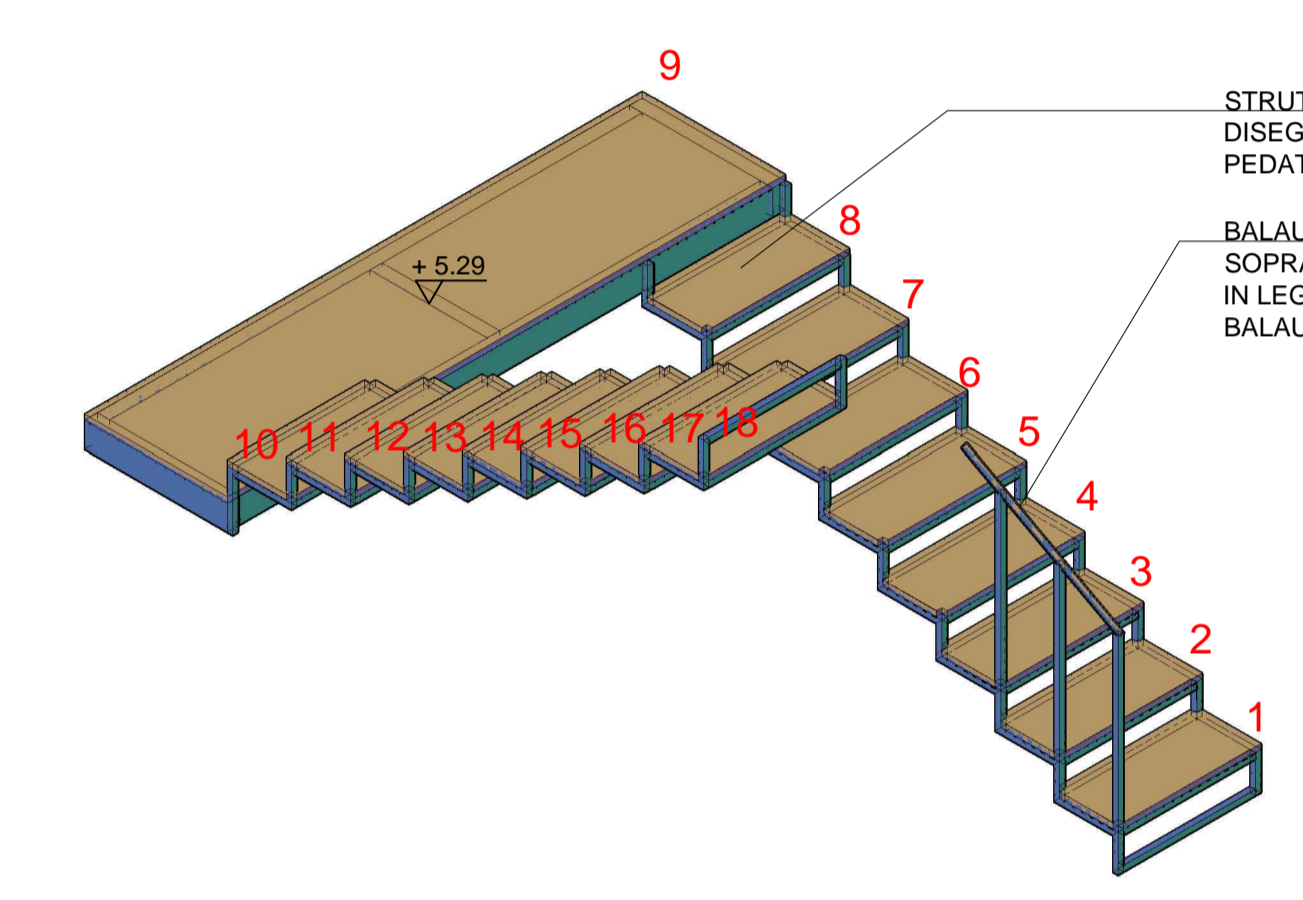
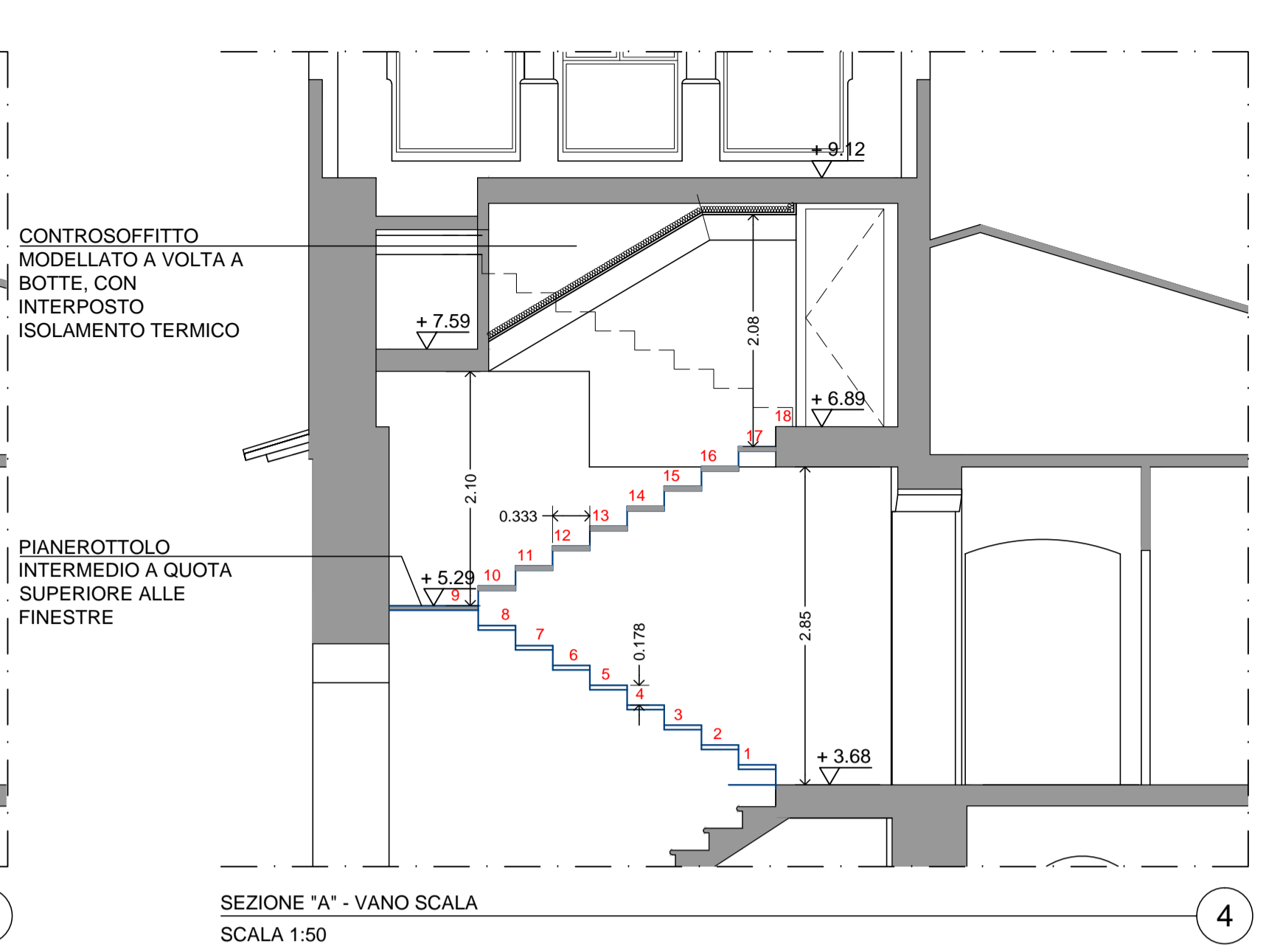
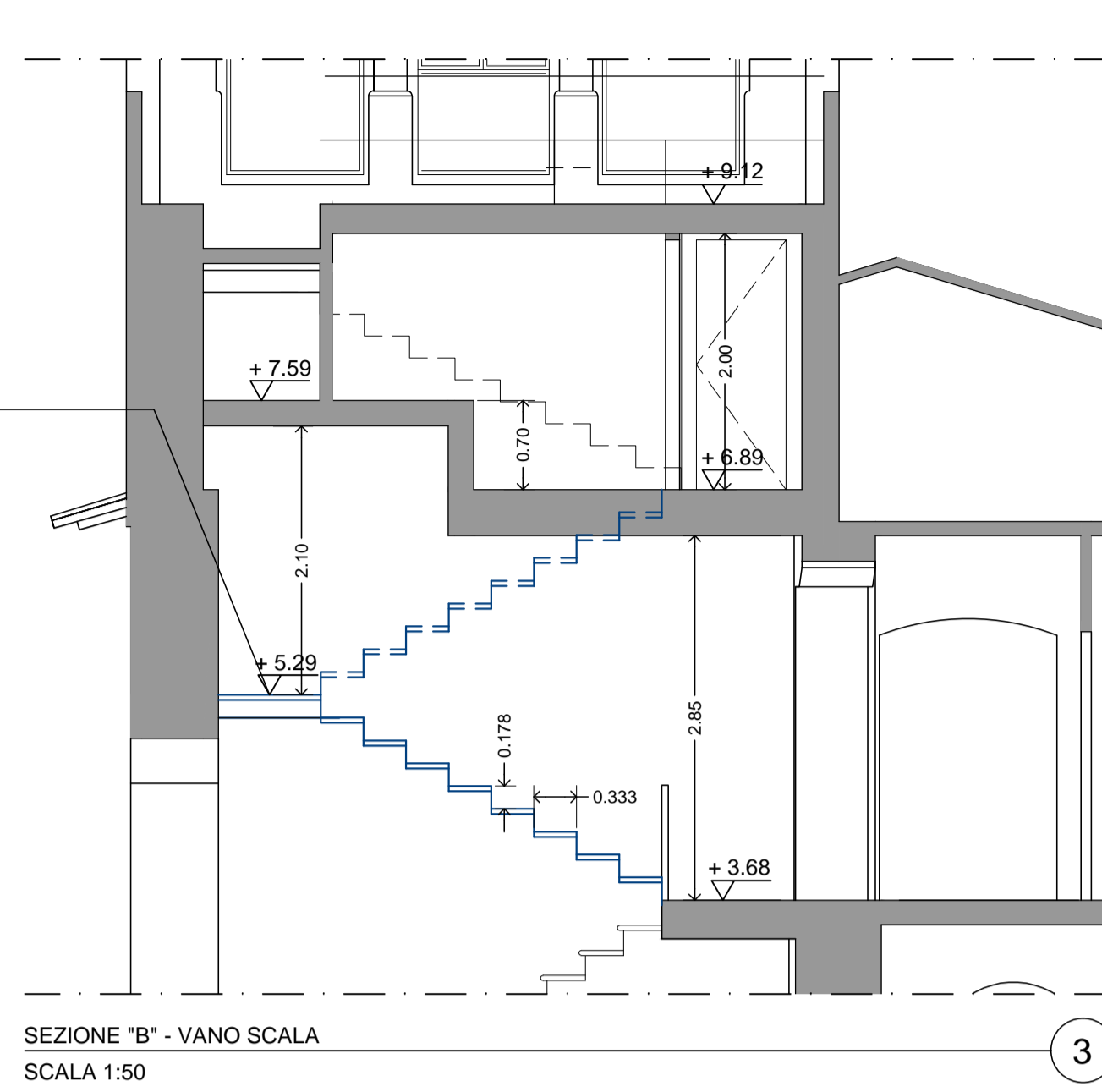
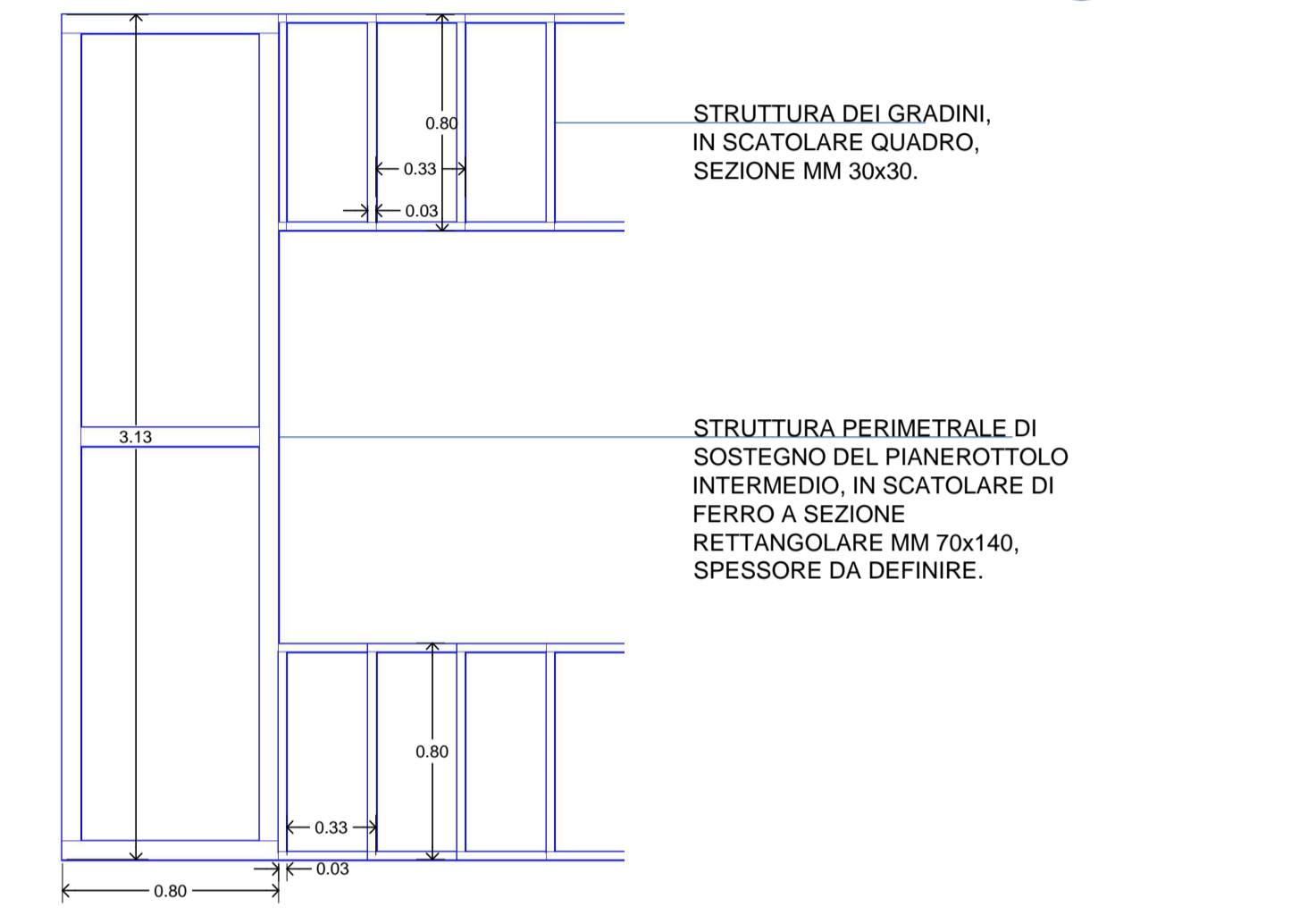
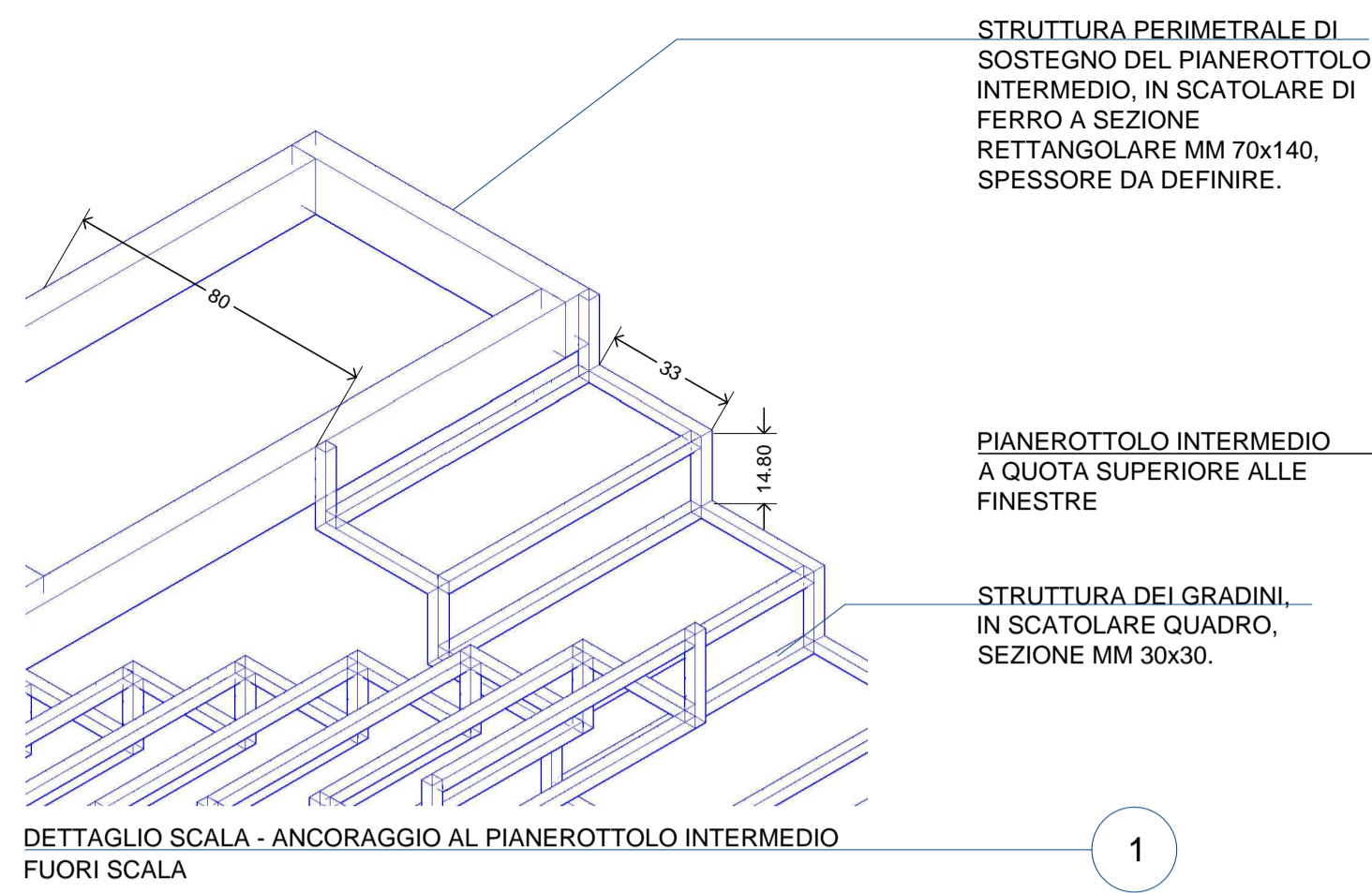

SCALA C.D.D. 11
 CODICE 11
 DATA _____

SCHEDA: PROGETTO NUOVA SCALA
 PROGETTO: VILLA E CANTINA DELL'AZIENDA AGRICOLA MONTEMELINO - Ristrutturazione
 Edilizia ed Ampliamento in Variante al PRG vigente e adottato - Procedimento SUAP
 ARCH. ANDREA PALOMBARO
 CORSO VITTORIO EMANUELE II, 282/284 - 00186 ROMA - ITALY
 TEL. STUDIO: 066882844 - FAX STUDIO: 066882664 - CELL.: 3471013386 - EMAIL: palombaro.studio@gmail.com
 REVISIONI: 1. _____ 2. _____ 3. _____ 4. _____